

# PANZERI® RINGS MOODBOARD





# PANZERI® RINGS MOODBOARD

## Planet Ring\_ Golden Ring\_ Silver Ring\_

Serie di anelli in alluminio verniciato bianco o foglia oro, a luce diretta/indiretta o a luce solo diretta e plafoniere anche ad incasso dotate di schede LED di potenza per soluzioni progettuali personalizzate in ambienti domestici o grandi composizioni per uffici, strutture ricettive e spazi pubblici. A richiesta altri colori per progetti.

Set of aluminum rings painted white or in gold leaf, direct/indirect or only direct light and white metal surface or recessed versions, equipped with power LEDs for customised design solutions for the home or large compositions for offices, hotels and public spaces. On request other colours for projects.

Weiß lackierte oder mit Blattgold beschichtete Aluminiumringe, mit direkter/indirekter Beleuchtung oder nur mit direkter Beleuchtung und ggf. einbaufähige Deckenleuchten mit LED-Leistungskarten für individuelle Gestaltungen in Wohnungen oder groß angelegten Büroräumen, Hotelbetrieben und öffentlichen Einrichtungen. Auf Anfrage sind für spezifische Projekte andere Farben lieferbar.

Familia de anillos de aluminio, completa de high-power LED chip, en color blanco o en pan de oro, con luz directa y indirecta en la versión de colgante y directa en el plafón y encastre. Ideal para habitaciones como para instalaciones de composiciones en ambientes receptivos de hoteles o despachos. Otros colores disponibles a petición.

Série d'anneaux en aluminium peint en blanc ou feuille d'or, à lumière directe/indirecte or simplement directe, et version plafond en métal blanc aussi, surface ou encastré, avec les conseils LED de puissance pour solutions de conceptions personnalisées à la maison ou grandes compositions pour les bureaux, les hôtels et les espaces publics. Sur demande autres couleurs.

Серия алюминиевых колец окрашенных в белый цвет или покрытых сусальным золотом, другие цвета доступны по запросу. Существуют версии с направленным и отраженным либо только направленным светом, белые металлические накладные или встраиваемые. Все версии оснащены мощными светодиодами и подойдут для индивидуальных дизайнерских решений для дома и больших композиций для офисов, гостиных и общественных помещений.



EuroLuce 2015 - Milano, Italia





Corporate Office - Holland



Bank Office - Switzerland



Shopping Gallery & Bar - Austria





Corporate Office - Bergamo, Italia



Corporate Office - Milano, Italia





Food Loft - Milano, Italia

Architect@Work 2015 - Milano, Italia









**Silver Ring** ceiling\_

Ø 180

**Golden Ring\_**

Ø 80

**Silver Ring\_**

Ø 120

Ø 80



**Golden Ring\_**

Ø 120

**Silver Ring\_**

Ø 180

Ø 120

Ø 80







## Golden Ring\_

Ø 120

Ø 180



**Planet Ring** suspension\_

Ø 100

Ø 70

**Planet Ring** recessed\_

Ø 70







# Golden Ring\_

Ø 120



**Silver Ring** wall\_

Ø 80

Ø 120

Ø 180







**Silver Ring** ceiling\_

Ø 180

Ø 80



**Silver Ring** ceiling\_

Ø 180

Ø 120

Ø 80

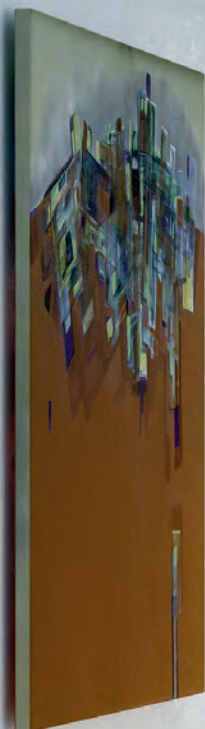

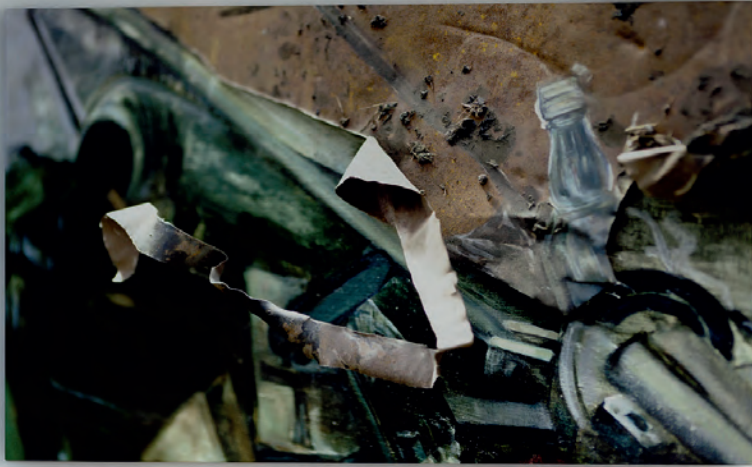

## Planet Ring

suspension\_

Ø 100

## Planet Ring\_

Ø 70

Ø 40







**Golden Ring\_**

Ø 80

**Silver Ring\_**

Ø 120

**Planet Ring\_**

Ø 100





# Planet Ring\_

Ø 40



**Silver Ring** \_

Ø 180

**Planet Ring** suspension\_

Ø 100

Ø 70





# Silver Ring\_

Ø 120

Ø 80









**Golden Ring\_**

Ø 120

**Silver Ring\_**

Ø 80



# Golden Ring\_

Ø 300





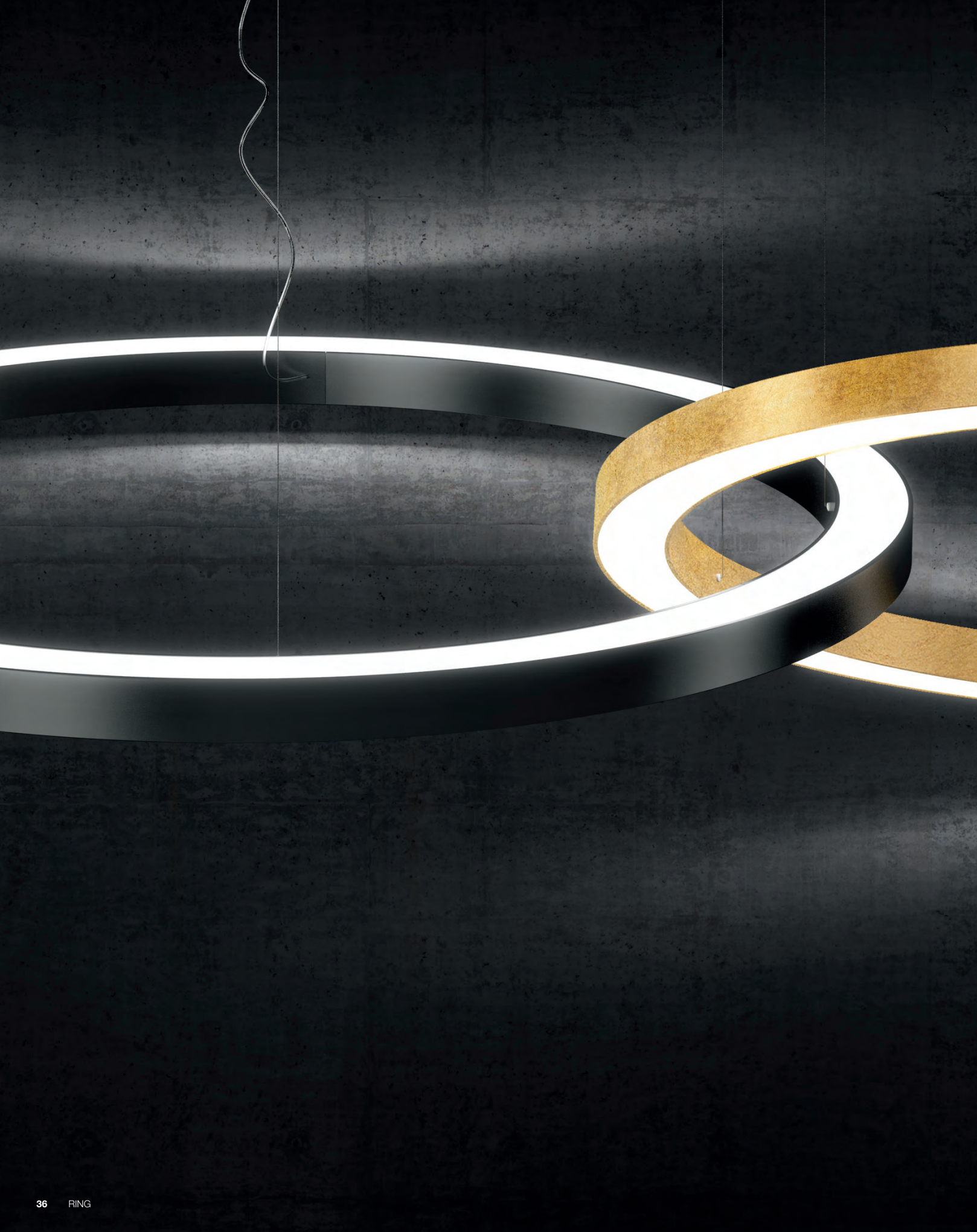

**Golden Ring\_**

Ø 300



# GOLDEN RING

Made in Italy

Design Enzo Panzeri 2015  
Registered Design







# GOLDEN RING

## SOSPENSIONI / SUSPENSIONS



L8101.800 MONO Direct light

L8121.800 MONO Direct light



Potenza assorbita apparecchio / Luminaire power consumption 48W  
Flusso luminoso apparecchio / Luminaire luminous flux 3115 lm  
3000K Ra 80 220-240V

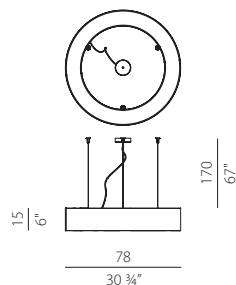

L8101.800 BIEM Direct light / Indirect light

L8121.800 BIEM Direct light / Indirect light



Potenza assorbita apparecchio / Luminaire power consumption 96W  
Flusso luminoso apparecchio / Luminaire luminous flux 3115 + 3115 lm  
3000K Ra 80 220-240V DALI/PUSH DIM\*

L8101.1200 Direct light / Indirect light

L8121.1200 Direct light / Indirect light

Potenza assorbita apparecchio / Luminaire power consumption 160W  
Flusso luminoso apparecchio / Luminaire luminous flux 5342 + 5342 lm  
3000K Ra 80 220-240V DALI/PUSH DIM\*

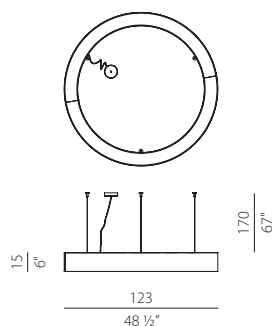

L8101.1800 Direct light / Indirect light

L8121.1800 Direct light / Indirect light

Potenza assorbita apparecchio / Luminaire power consumption 238W  
Flusso luminoso apparecchio / Luminaire luminous flux 8005 + 8005 lm  
3000K Ra 80 220-240V DALI/PUSH DIM\*

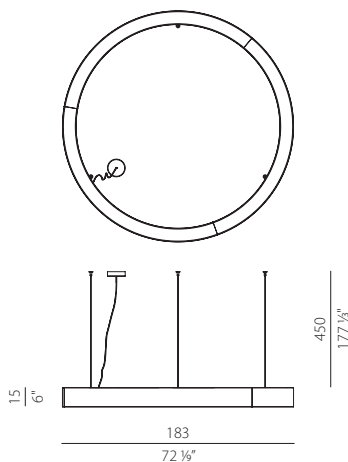

M8101-3

Rosone opzionale per raggruppamento cavi acciaio (Ø 800-1200-1800)  
Optional canopy to join steel cables (Ø 800-1200-1800)

M8121-3

Rosone opzionale per raggruppamento cavi acciaio (Ø 800-1200-1800)  
Optional canopy to join steel cables (Ø 800-1200-1800)

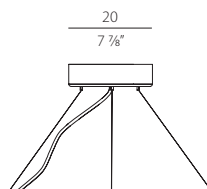



01 Bianco / White



21 Foglia oro / Gold leaf

Per progetti disponibili a richiesta altri colori.  
On request other colors for projects.

L8101.3000\*\* Direct light / Indirect light

L8121.3000\*\* Direct light / Indirect light

Potenza assorbita apparecchio / Luminaire power consumption 398W  
Flusso luminoso apparecchio / Luminaire luminous flux 13350 + 13350 lm  
3000K Ra 80 220-240V DALI/PUSH DIM\*

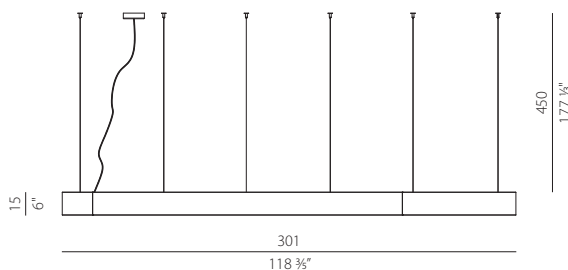
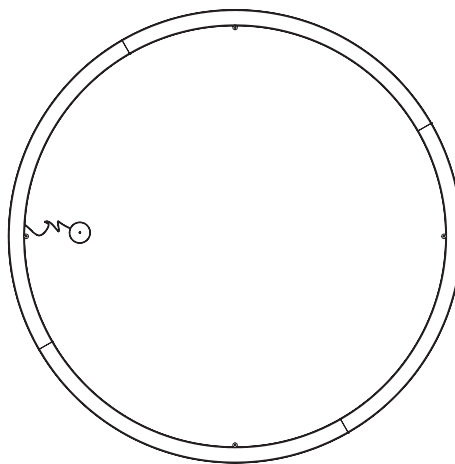

### M8101-6

Rosone opzionale per raggruppamento cavi acciaio (Ø 3000)  
Optional canopy to join steel cables (Ø 3000)

### M8121-6

Rosone opzionale per raggruppamento cavi acciaio (Ø 3000)  
Optional canopy to join steel cables (Ø 3000)

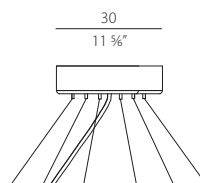

- \* 800 BIEM max 4 fixtures push dim
- 1200 max 2 fixtures push dim
- 1800 max 2 fixtures push dim
- 3000 max 1 fixtures push dim

\*\* Fixture in 2 parts to compose

# GOLDEN RING



# SILVER RING



# SILVER RING

Made in Italy

Design Enzo Panzeri 2016





# SILVER RING

## SOSPENSIONI / SUSPENSIONS



L8201.800 Direct light

L8221.800 Direct light

Potenza assorbita apparecchio / Luminaire power consumption 48W  
Flusso luminoso apparecchio / Luminaire luminous flux 3115 lm  
3000K Ra 80 220-240V DALI/PUSH DIM\*

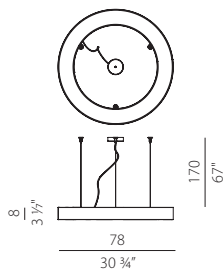

L8201.1200 Direct light

L8221.1200 Direct light

Potenza assorbita apparecchio / Luminaire power consumption 81W  
Flusso luminoso apparecchio / Luminaire luminous flux 5342 lm  
3000K Ra 80 220-240V DALI/PUSH DIM\*

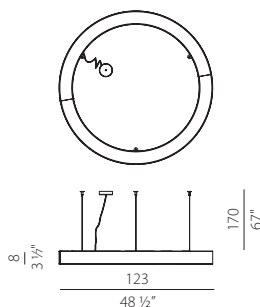

L8201.1800 Direct light

L8221.1800 Direct light

Potenza assorbita apparecchio / Luminaire power consumption 120W  
Flusso luminoso apparecchio / Luminaire luminous flux 8005 lm  
3000K Ra 80 220-240V DALI/PUSH DIM\*

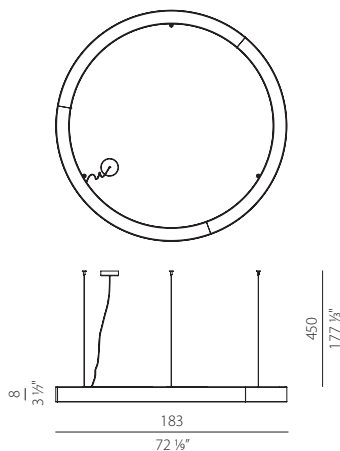

\* 800 / 1200 / 1800 max 4 fixtures push dim



# SOFFITTO-PARETE / CEILING-WALL

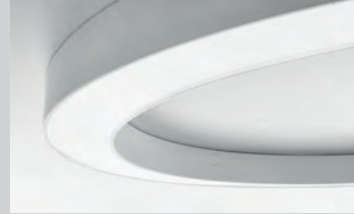

01 Bianco / White

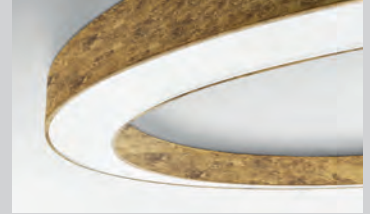

21 Foglia oro / Gold leaf

Per progetti disponibili a richiesta altri colori.  
On request other colors for projects.

P8201.800

P8221.800

Potenza assorbita apparecchio / Luminaire power consumption 48W  
Flusso luminoso apparecchio / Luminaire luminous flux 3115 lm  
3000K Ra 80 220-240V DALI/PUSH DIM\*

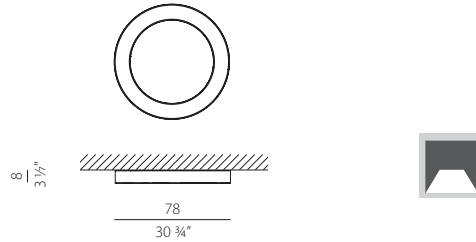

P8201.1200

P8221.1200

Potenza assorbita apparecchio / Luminaire power consumption 81W  
Flusso luminoso apparecchio / Luminaire luminous flux 5342 lm  
3000K Ra 80 220-240V DALI/PUSH DIM\*

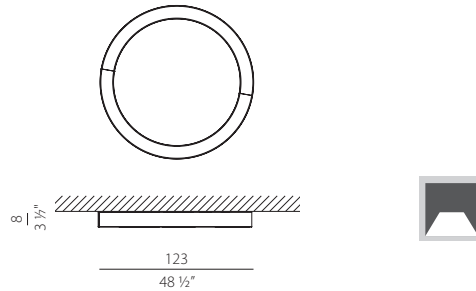

P8201.1800

P8221.1800

Potenza assorbita apparecchio / Luminaire power consumption 120W  
Flusso luminoso apparecchio / Luminaire luminous flux 8005 lm  
3000K Ra 80 220-240V DALI/PUSH DIM\*

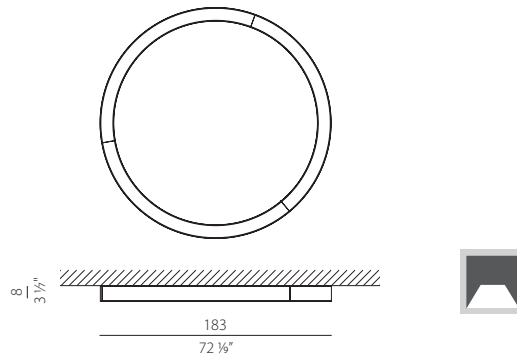

\* 800 / 1200 / 1800 max 4 fixtures push dim

# PLANET RING

Made in Italy

Design Studio Tecnico 2016

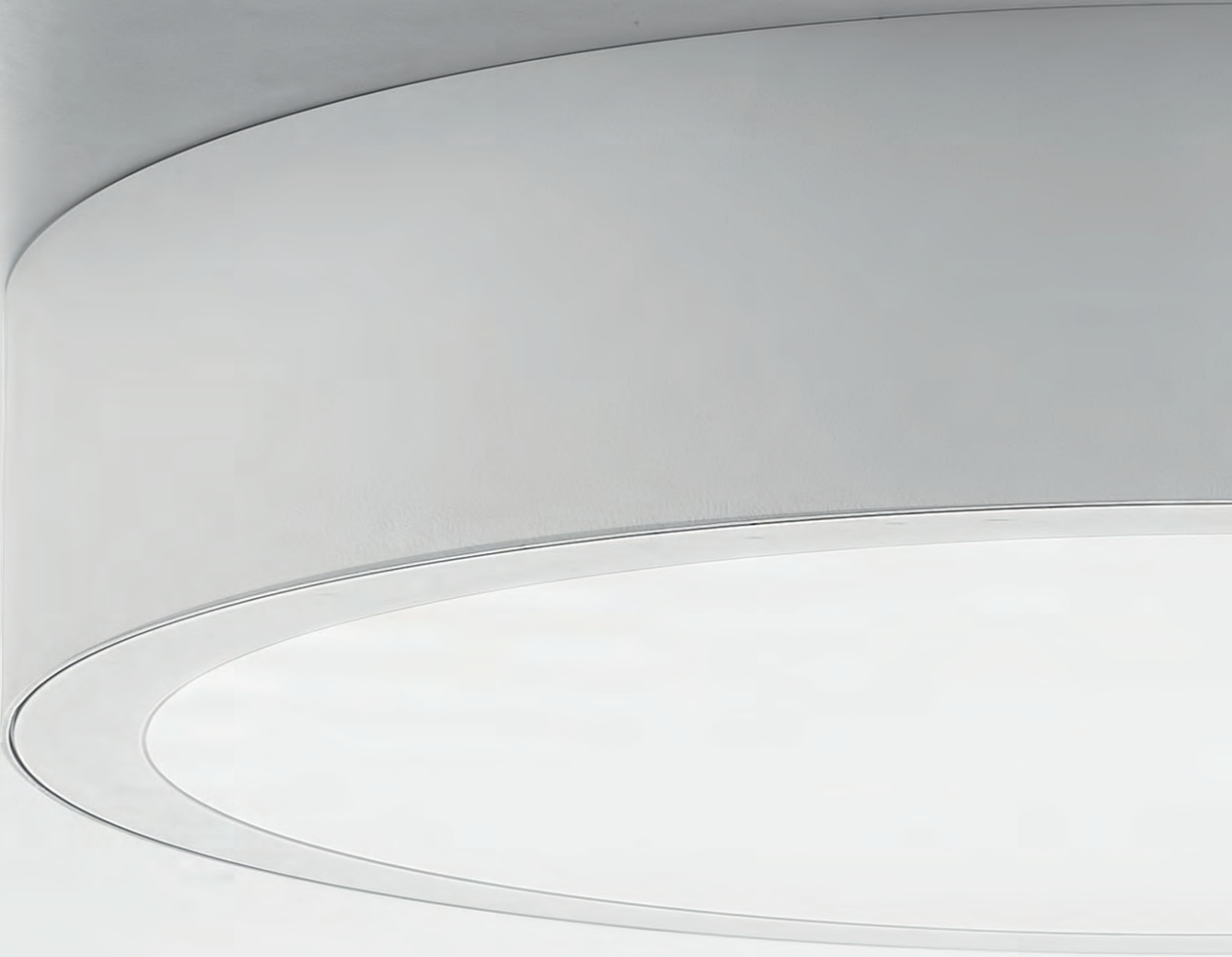



# PLANET RING

SOFFITTO / CEILING

SOSPENSIONE / SUSPENSION



Struttura in metallo verniciato bianco.  
Lastra in policarbonato opale.  
Disponibile schermo microprismato per progetti.

White metal structure.  
Opal polycarbonate diffuser.  
Available for projects microprismatic diffuser.



01 Bianco / White

Per progetti disponibili a richiesta altri colori.  
On request other colors for projects.

P8301.400

P8301.400 DALI DALI/PUSH DIM

P8301.400 EM 1H/12H EMERGENCY

Potenza assorbita apparecchio / Luminaire power consumption 28,6W  
Flusso luminoso apparecchio / Luminaire luminous flux 2315 lm  
3000K Ra 80 220-240V (4000K a richiesta / on request)

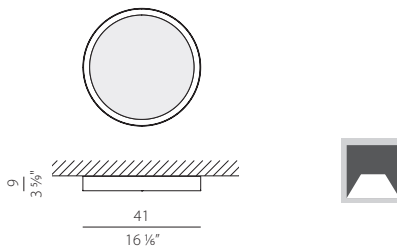

P8301.700

P8301.700 DALI DALI/PUSH DIM

P8301.700 EM 1H/12H EMERGENCY

Potenza assorbita apparecchio / Luminaire power consumption 72W  
Flusso luminoso apparecchio / Luminaire luminous flux 6173 lm  
3000K Ra 80 220-240V (4000K a richiesta / on request)

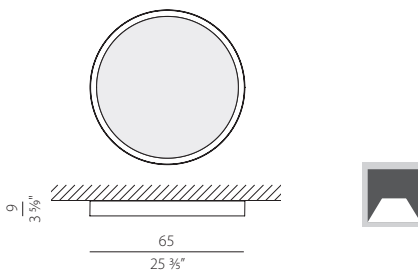

L8301.700

L8301.700 DALI DALI/PUSH DIM

L8301.700 EM 1H/12H EMERGENCY

Potenza assorbita apparecchio / Luminaire power consumption 72W  
Flusso luminoso apparecchio / Luminaire luminous flux 6173 lm  
3000K Ra 80 220-240V (4000K a richiesta / on request)

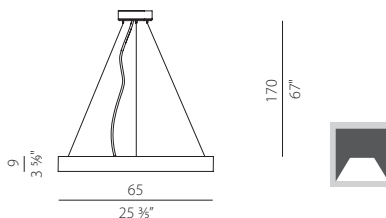

P8301.1000

P8301.1000 DALI DALI/PUSH DIM

P8301.1000 EM 1H/12H EMERGENCY

Potenza assorbita apparecchio / Luminaire power consumption 139W  
Flusso luminoso apparecchio / Luminaire luminous flux 12345 lm  
3000K Ra 80 220-240V (4000K a richiesta / on request)

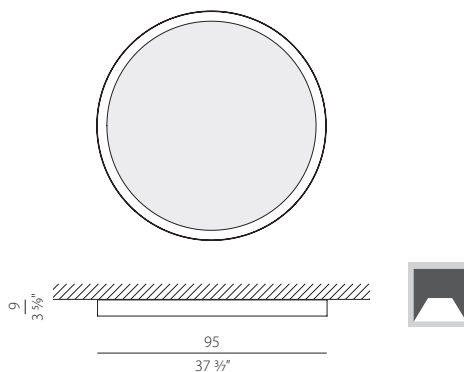

L8301.1000

L8301.1000 DALI DALI/PUSH DIM

L8301.1000 EM 1H/12H EMERGENCY

Potenza assorbita apparecchio / Luminaire power consumption 139W  
Flusso luminoso apparecchio / Luminaire luminous flux 12345 lm  
3000K Ra 80 220-240V (4000K a richiesta / on request)

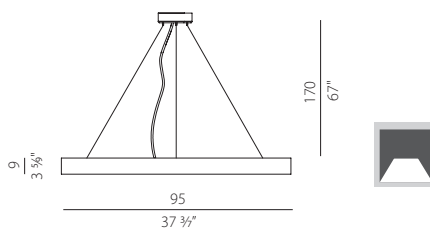

# INCASSO / RECESSED



CE IP40



01 Bianco / White

P8301.400 IN  
P8301.400 IN DALI DALI/PUSH DIM  
P8301.400 IN EM 1H/12H EMERGENCY

Potenza assorbita apparecchio / Luminaire power consumption 28,6W  
Flusso luminoso apparecchio / Luminaire luminous flux 2315 lm  
3000K Ra 80 220-240V (4000K a richiesta / on request)

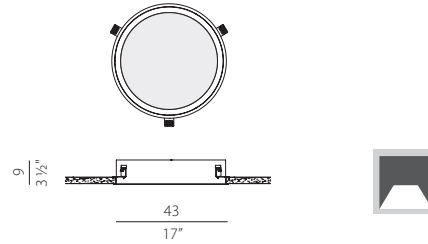

P8301.700 IN  
P8301.700 IN DALI DALI/PUSH DIM  
P8301.700 IN EM 1H/12H EMERGENCY

Potenza assorbita apparecchio / Luminaire power consumption 72W  
Flusso luminoso apparecchio / Luminaire luminous flux 6173 lm  
3000K Ra 80 220-240V (4000K a richiesta / on request)

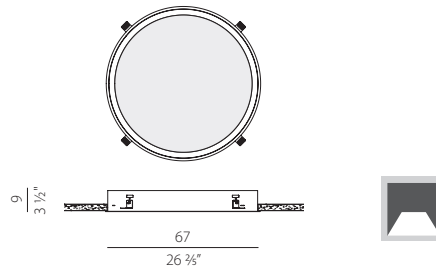

P8301.1000 IN  
P8301.1000 IN DALI DALI/PUSH DIM  
P8301.1000 IN EM 1H/12H EMERGENCY

Potenza assorbita apparecchio / Luminaire power consumption 139W  
Flusso luminoso apparecchio / Luminaire luminous flux 12345 lm  
3000K Ra 80 220-240V (4000K a richiesta / on request)

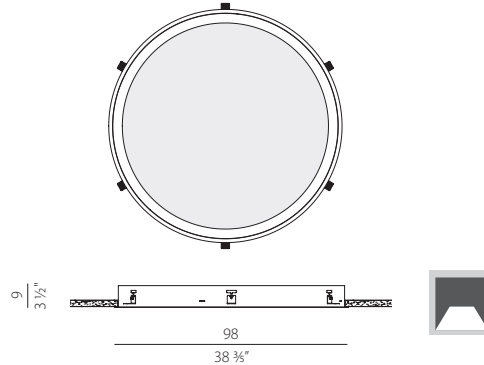

Your creativity mixed with our products



*an idea...*

*...and now sketch  
your moodboard!*

**CE** Prodotto conforme alle norme di sicurezza e alle direttive europee vigenti.  
Product complying with safety rules and EU directives.  
Das Produkt entspricht den gültigen Sicherheitsvorschriften und EU-Richtlinien.  
Produit conforme aux règles de sécurité et aux règlements de l'union européenne.  
Producto conforme a la norma de seguridad y a las directivas europeas.  
Продукт отвечает требованиям безопасности и директивам ЕС.

**IP..** **Grado di protezione**  
Il grado di protezione degli apparecchi di illuminazione viene indicato con la sigla "IP" seguita da due cifre caratteristiche.  
- la prima indica la protezione contro la penetrazione dei corpi solidi e della polvere  
- la seconda indica la protezione contro la penetrazione dei liquidi  
**Protection Index**  
The protection rating of the lighting appliances is shown by the letters "IP" followed by two characteristic digits.  
- the first of these two digits indicates the degree of protection that the appliances offer against the entry of solid foreign objects  
- the second one indicates the protection against the entry of water  
**Berührungs- und Fremdkörperschutz**  
Der Schutzgrad des Beleuchtungsgerätes wird mit der Abkürzung "IP" und zwei bestimmten Zahlen genannt.  
- die erste beschreibt den Schutz gegen das Eindringen von Festkörpern und Staub  
- die zweite beschreibt den Schutz gegen Flüssigkeiten  
**Grado de protección**  
El grado de protección de los aparatos de iluminación se indica con el símbolo "IP" seguido de dos números característicos.  
- el primer número indica el grado de protección contra la penetración de polvo, de cuerpos sólidos  
- el segundo indica la protección contra los líquidos  
**Degré de protection**  
Le degré de protection des appareils d'éclairage est indiqué par le symbole "IP" suivi de deux numéros caractéristiques.  
- le premier numéro identifie la protection contre la pénétration des corps solides, de la poussière  
- le deuxième identifie la protection contre la pénétration des liquides  
Степень защиты  
Степень защиты светильника от внешних воздействий обозначается кодом IP и двумя цифрами.  
- первая цифра обозначает степень защиты от проникновения внутрь посторонних предметов и пыли  
- вторая цифра показывает стойкость к воздействию влаги

**RoHS** RoHS - DIRETTIVA 2002/95/CE (Restriction of the use of certain Hazardous Substances in electrical and electronic equipment) Direttiva europea che limiti l'utilizzo di alcune sostanze pericolose (piombo, cadmio, mercurio, cromo esavalente, bifenile polibromurati, Eteri difendi polibromurati. A partire da 1 luglio 2006 tali sostanze non possono essere più impiegate nei prodotti elettrici ed elettronici, salvo deroghe su alcune applicazioni.  
RoHS - DIRECTIVE 2002/95/CE (Restriction of the use of certain Hazardous Substances in electrical and electronic equipment). The European Directive restricts the use of some dangerous substances: lead, mercury, cadmium, hexavalent chromium, polybrominated biphenyls (PBB) or polybrominated diphenyl ethers (PBDE). From 1st July 2006 such substances shall not be used anymore in electrical and electronic equipment apart from exceptions on specific applications.  
RoHS - RICHTLINIE 2002/95/CE (Restriction of the use of certain Hazardous Substances in electrical and electronic equipment). Die Eu Richtlinie stellt, dass ab dem 1. Juli 2006 neu in Verkehr gebrachte Elektro- und Elektronengeräte kein Blei, Quecksilber, Cadmium, sechswertiges Chrom, polybromiertes Biphenyl (PBB) bzw. polybromierte Diphenylether (PBDE) enthalten sollen.  
RoHS - DIRECTIVA 2002/95/CE (Restriction of the use of certain Hazardous Substances in electrical and electronic equipment). La Directiva impone que, a partir del 1 de julio de 2006, los nuevos aparatos eléctricos y electrónicos que se pongan en el mercado no contengan plomo, mercurio, cadmio, cromo hexavalente, polibromobifenilos (PBB) o polibromodifeniléteres (PBDE).  
RoHS - DIRECTIVE 2002/95/CE (Restriction of the use of certain Hazardous Substances in electrical and electronic equipment). La directive européenne prévoit que à compter du 1er juillet 2006, les nouveaux équipements électriques et électroniques mis sur le marché ne contiennent pas de plomb, de mercure, de cadmium, de chrome hexavalent, de polybromobiphényles (PBB) ni de polybromodiphényléthers (PBDE).  
RoHS - DIRETTIVA 2002/95/CE (Restriction of the use of certain Hazardous Substances in electrical and electronic equipment) Европейская директива, которая ограничивает использование некоторых опасных веществ (свинца, кадмия, ртути, шестивалентного хрома, полибромированных бифенилов (PBB) и полибромированных дифениловых эфиров (PBDE)). С 1 июля 2006 года эти вещества не могут быть больше использованы для производства электрического и электронного оборудования, за исключением некоторых специальных применений.

**EAC** Marchio unico di certificazione EAC (EurAsian Certification) che sostituisce i marchi nazionali GOST (R per la Russia, B per Bielorussia e K per Kazakistan)  
Unique brand of EAC certification (Eurasian Certification) which replaces the national GOST brands (R for Russia, B for Belarus and K for Kazakhstan).  
Einiges Markenzeugnis EAC, als Ersatzung des Landesmarkengost (R für Russia, B für Bielorussia und K für Kazakistan).  
Marca única de certificación EAC que substituye las marcas nacionales Gost (R por Russia, B por Belarus y K por Kazakistan).  
Marque unique de conformité EAC, qui substitue les marques nationales Gost (R pour Russia, B pour Belarus et K pour Kazakistan).  
EAC, англ. Eurasian Conformity — знак обращения, свидетельствующий о том, что продукция, маркированная им, прошла все установленные в технических регламентах Таможенного союза процедуры оценки.

**DALI/PUSH DIM** Dimmer con funzionalità DALI o pulsante normalmente aperto NA  
Dimmer for DALI protocol or push button application

**1H/12H EMERGENCY** Emergenza integrata. Autonomia 1h / Tempo di ricarica 12h  
Integrated emergency. Duration 1h/Recharging time 12h



CONSORZIO PER LA RACCOLTA E LO SMALTIMENTO DELLE APPARECCHIATURE DI ILLUMINAZIONE.

PANZERI CARLO SRL ADERISCE AL CONSORZIO ECOLIGHT – MILANO ITALY

WEEE - DIRETTIVA 2002/96/CE, 2003/108/CE (WASTE ELECTRICAL AND ELECTRONIC EQUIPMENT) RIFIUTI DI APPARECCHI ELETTRICI ED ELETTRONICI.

La direttiva valida su tutto il territorio dell'Unione Europea definisce una serie di misure allo scopo di prevenire la produzione di rifiuti di apparecchiature elettriche ed elettroniche; di promuovere il riuso, il riciclo ed altre forme di recupero di tali tipologie di rifiuti; di limitare i rischi di impatto sull'ambiente derivanti dal trattamento e dallo smaltimento dei rifiuti in questione; di armonizzare le misure nazionali di gestione dei rifiuti elettrici ed elettronici.

Gli apparecchi di illuminazione marcati con l'apposito simbolo del cassonetto barrato  sono soggetti a raccolta differenziata separata dal resto dei rifiuti urbani.

Per la restituzione di un dispositivo dimesso, occorre servirsi dei sistemi di restituzione e di raccolta messi a disposizione nei singoli paesi di utilizzo.

PANZERI CARLO SRL JOINS CONSORZIO ECOLIGHT – MILANO ITALY

WEEE - DIRECTIVE 2002/96/CE, 2003/108/CE (WASTE ELECTRICAL AND ELECTRONIC EQUIPMENT).

The European Directive is applicable throughout the European Union and determines the measures in order to prevent the production of waste electrical and electronic equipment; to promote the re-use, the recycle and other forms of reutilization of these kind of waste; to restrict the risks of impact to the environment coming from treatment and disposal of these equipments; to harmonize national measures of managing waste electrical and electronic equipment.

Equipment marked with proper symbol of crossed container  may not be disposed of with household rubbish.

To return the used device, the return and collection systems available in every single Country must be used.

PANZERI CARLO SRL GEHÖRT DEM CONSORZIO ECOLIGHT (MILANO – ITALY) AN.

WEEE - RICHTLINIE 2002/96/CE, 2003/108/CE (WASTE ELECTRICAL AND ELECTRONIC EQUIPMENT).

Die Eu Richtlinie gibt den Rahmen für die EU-weit gültige Maßnahmen, um die Produktion von Elektro- und Elektronik-Altgeräte zu verhindern; um Rückführung und andere Formen von Wiederverwendung zu fördern; um Einschränkung der Risiken gegen die Umwelt, die diese Abfälle verursachen können; um die Ländermaßnahme im Rahmens der Elektro- und Elektronik-Altgeräte zu harmonisieren.

Das Gerät gezeigt mit der bestimmten Kennzeichnung  dürfen nicht mit dem Siedlungsabfall entsorgt werden.

Für die Rückgabe des Altgeräts muss man die verfügbare Rückgabe- und Sammelsysteme in jedem Gebrauchsland nutzen.

PANZERI CARLO SRL HACE PARTE DEL CONSORZIO ECOLIGHT – MILANO ITALY

WEEE - DIRECTIVA 2002/96/CE, 2003/108/CE (WASTE ELECTRICAL AND ELECTRONIC EQUIPMENT).

La directiva es valida en toda la Union Europea y señala las medidas necesarias para prevenir la producción de residuos de aparatos eléctricos y electrónicos; para promover el reutilizo, reciclo y otras formas de recupero de estas tipologias de residuos; para limitar los efectos en el medio ambiente que vienen de los tratamientos y gestion de estos residuos; para armonizar las medidas nacionales de gestion de residuos de aparatos eléctricos y electrónicos.

El equipo marcado con signal de contenedor tachado  no debe eliminarse junto con la basura urbana.

Para la devolución de antiguo dispositivo utilizar los sistemas de recogida y devolución disponible en cada Pais.

PANZERI CARLO SRL ADHÈRE AU CONSORZIO ECOLIGHT – MILANO ITALY

WEEE - DIRECTIVE 2002/96/CE, 2003/108/CE (WASTE ELECTRICAL AND ELECTRONIC EQUIPMENT).

La directive valable sur tout le territoire de l'Union Européenne établit des mesures afin d'éviter la production de déchets d'équipements électriques et électroniques; d'encourager la réutilisation des équipements usagés, le recycle et autres formes de récupération de ces typologies de déchets; de limiter les risques sur l'environnement causés par le traitement de ces déchets et par la relative élimination; d'harmoniser les dispositions nationales de gestion des déchets électriques et électroniques.

Les appareils d'éclairage marqués avec le symbole du porte-poubelle barré,  sont sujet à la collecte séparée des autres déchets urbains. Pour la restitution d'un dispositif usagé, il faut se servir des systèmes de restitution et de collecte offerts dans chaque pays d'utilisation.

PANZERI CARLO SRL ВХОДИТ В СОСТАВ CONSORZIO ECOLIGHT – MILANO ITALY

WEEE - ДИРЕКТИВА 2002/96/CE, 2003/108/CE (WASTE ELECTRICAL AND ELECTRONIC EQUIPMENT) УТИЛИЗАЦИЯ ЭЛЕКТРИЧЕСКОГО И ЭЛЕКТРОННОГО ОБОРУДОВАНИЯ.

Директива действует на территории всего Европейского Союза и определяет ряд мер, целью которых является избежание накопления отходов электрического и электронного оборудования; содействие их повторному использованию, переработке и другим методам утилизации этого вида отходов; уменьшение рисков воздействия на окружающую среду при переработке и уничтожении отходов; приведение в соответствие национальных мер по контролю за утилизацией электрического и электронного оборудования.

Светильники, отмеченные символом с перечеркнутым мусорным контейнером,  нельзя выбрасывать с остальным бытовым мусором. Для их переработки следует обращаться в соответствующие государственные учреждения.

Pur mantenendo inalterate le proprie caratteristiche di base, i nostri articoli possono risultare parzialmente modificati rispetto a come sono raffigurati nel presente catalogo. Ciò è dovuto all'evoluzione a cui sottoponiamo i prodotti, con lo scopo di un miglioramento continuo. Anche i colori presentati nel catalogo sono da considerarsi puramente indicativi.

While maintaining the basic characteristics of the product, the Company reserves the right to make modifications at any time with the sole aim of improvement. The colours illustrated in the catalogue are intended only as examples.

Unter Beibehaltung der wesentlichen Produktcharakteristiken behält sich die Firma jederzeit Änderungen zur Verbesserung der Produkte vor. Die in Katalog abgebildeten Farben sind unverbindlich.

Manteniendo las características base del producto, la Sociedad se reserva el derecho de realizar pequeños cambios con el fin de mejorar la calidad del producto. Los colores que se ven en el catálogo son sólo indicativos.

Tout en respectant les caractéristiques de base du produit, la Societe se réserve le droit d'apporter modifications en tous les moments rien que pour amélioration. Les couleurs illustrées dans ce catalogue sont données à titre d'indication.

Возможно некоторое отличие наших артикулов от их изображения в этом каталоге, при сохранении неизменными их основных характеристик. Это связано с нашим постоянным стремлением к усовершенствованию моделей. Отделки, представленные в каталоге, так же должны рассматриваться как чисто ориентировочные.

# PANZERI®

PANZERI CARLO S.R.L.  
Via Padania, 8 - 20853  
Biancospino MB - Italy  
Sede Legale: Via Mameli, 11  
20851 Lissone MB - Italy  
T +39 039 2497483  
F +39 039 2497396  
panzeri@panzeri.it  
export@panzeri.it  
[www.panzeri.it](http://www.panzeri.it)



ADERENTE AD ASSOLOMBARDA  
CONFINDUSTRIA MILANO MONZA E BRIANZA



*Riconoscimento attribuito per oltre 50 anni di attività  
Recognition given for over 50 years of continuous activity*



**ADI** MEMBER

**ADI** ASSOCIAZIONE PER IL DISEGNO INDUSTRIALE



**PANZERI.IT**